

LIVALITE

Modular Lighting System





Express yourself with light. The Modular System frees your creativity with light bars, blanks and connectors that can be snapped together to design personalized sculptural motifs or to enhance the architecture of your space with distinctive, contemporary linear accent lighting.

EXPLORE THE ENDLESS POSSIBILITIES WITH Modular Lighting System

It can be designed as a decorative modern chandelier or as an architectural accent. This system allows multi-dimensionality for suspending unique geometric shapes, linear lighting, task lighting, or distinctive light sculpture — a system with endless possibilities.

Customize your design with countless configurations:



Linear Bar



Geometric Pendant

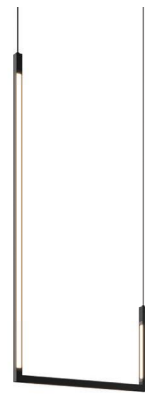

Deconstructed Rectangle



Vertical Pendant



Organic Multi-tiered Pendants

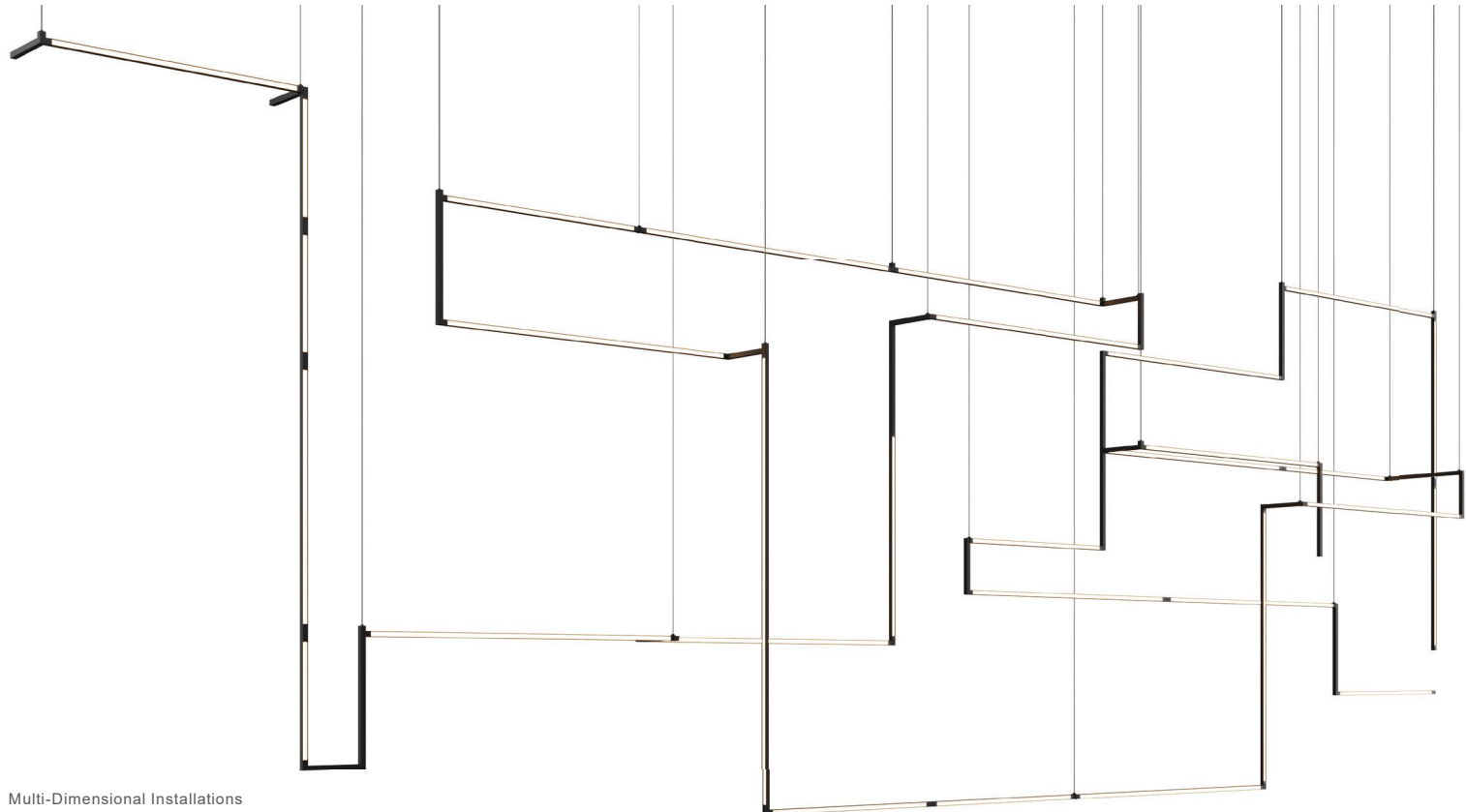

Multi-Dimensional Installations



FEATURES

LIGHT & BLANK BARS

Length: 30cm, 60cm, 120cm, 180cm

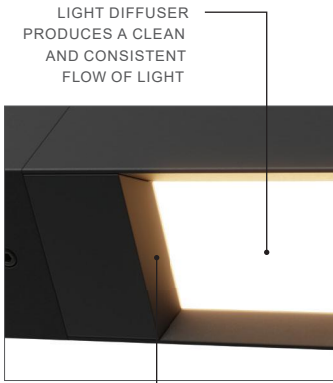

BEVELED EDGE HELPS
REDUCE GLARE AND
CREATES A CLEAN,
MODERN AESTHETIC

ADJUSTABILITY

360° rotating and lockable
LED Light Bars for direct or
indirect illumination



BLANK BARS

Blanks can connect
illuminated sections

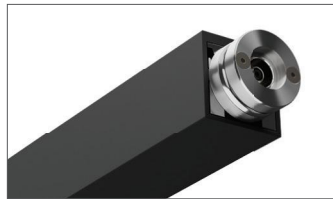

INSTALLATION

Easy and rapid installation with snap-in Connectors and Locking Allen screws

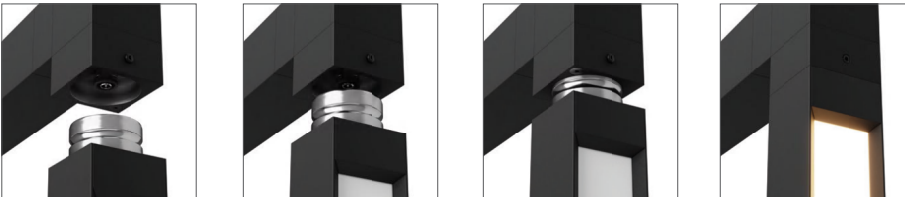

CONNECTIVITY

Flexible Connectors: I, L, T, X, Wall Mount and Corner Connectors (3-, 4-, 5-way)

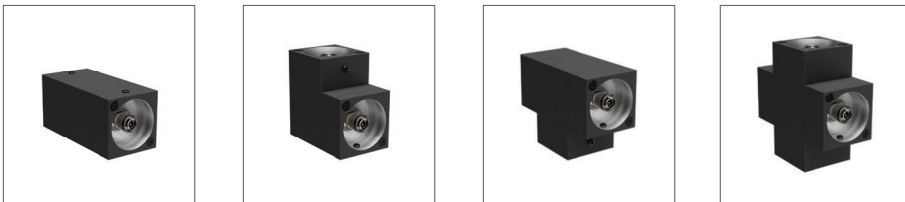

To view all connectors, see p.15

MOUNTING AND POWER SOURCE

Remote Power Supply & Aircraft Cable Ceiling Suspension



See p.15 for additional details and ordering grids



DESIGNING WITH Modular Lighting System — ALL THE PARTS TO BUILD YOUR SYSTEM

They are available in multiple lengths and rotate 360° to provide flexibility in design and accommodate direct or indirect lighting. Blank Bars allow the option to design without light, and a multitude of connectors are offered to build your design in three dimensions.

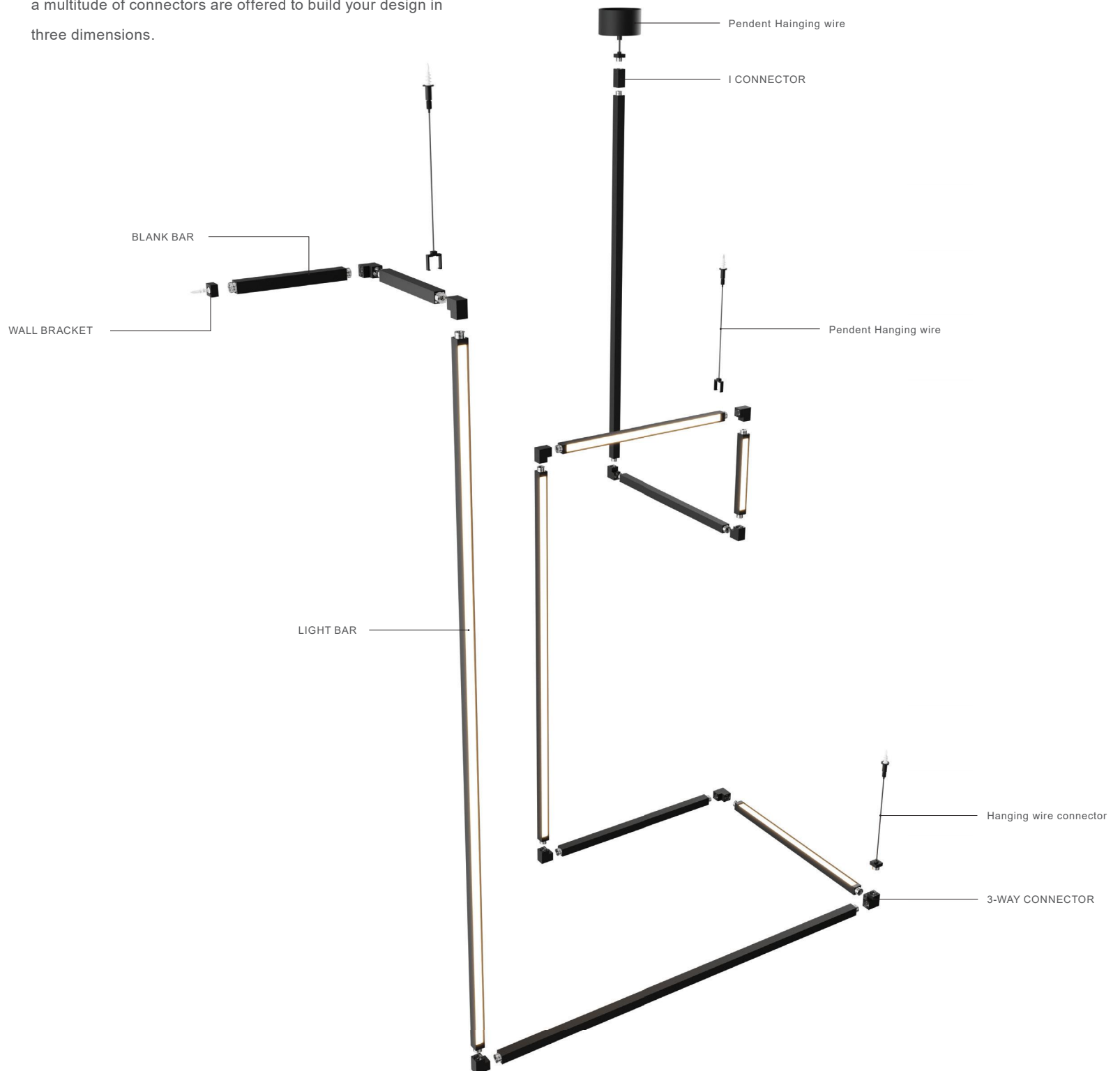

BUILDING YOUR SYSTEM

It is an easy-to-install system with components that snap together and lock into place with simple Allen screws.



Connectors allow you to design your system with multiple dimensions at any 90° angle.

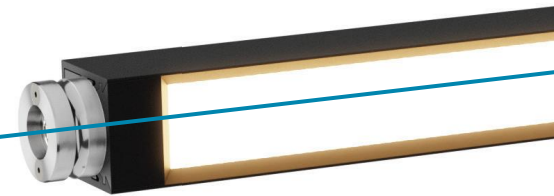
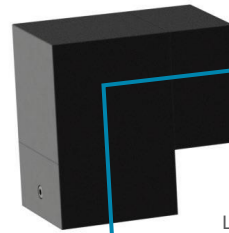

Low-voltage power flows from one to the next. For larger installations requiring multiple power feeds, our team can help with layouts and create drawings.

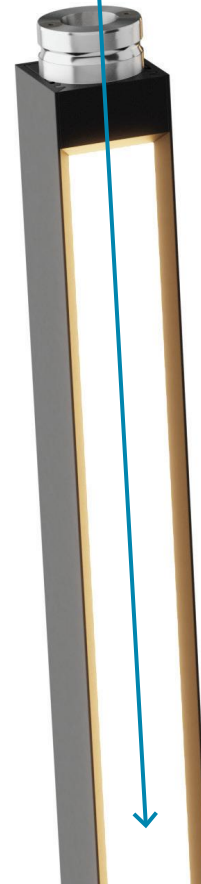

Remote Driver



Surface Driver



Choose between two options to supply power to your own system - a minimal ceiling approach with the remote driver option or if access above your ceiling is limited the surface canopy option.

Use connectors to drop power to your system or link long runs together.

Supports at each corner maintain a secure and level system. If placed directly on the Light Bar, rotation is limited to every 90°.

Support can be mounted on the connector to allow for 360° rotation.

360°
ROTATION

Light Bars rotate 360° to aim light in your preferred direction.

Vertical and Horizontal Light Bars also available as Blank Bars.

Finish each run with an end cap.

Wall Connector provides design flexibility to mount light bars on wall or ceiling.





LIGHT BAR COMPONENTS &
PRE-CONFIGURED SYSTEMS





LIGHT BARS



SPECIFICATIONS

DELIVERED LUMENS 60 + LUMENS PER Watt

WATTS 2W/4W/8W/12W

INPUT VOLTAGE/
DIMMING SURFACE: 230V
REMOTE: 230V
0-10V

DIMMING DIMS BELOW 3%

CCT 3000K

CRI 90 CRI

FINISH Nightshade Black

LED LIFETIME L70; 70,000 Hours

WARRANTY* 5 Years

* Visit techlighting.com for specific warranty limitations and details.

SERIES	LENGTH (A)	CRI	COLOR TEMPERATURE	HARDWARE FINISH
Light Bar	30cm 60cm 120cm 180cm	90 CRI	3000K	NIGHTSHADE BLACK



BLANK BARS

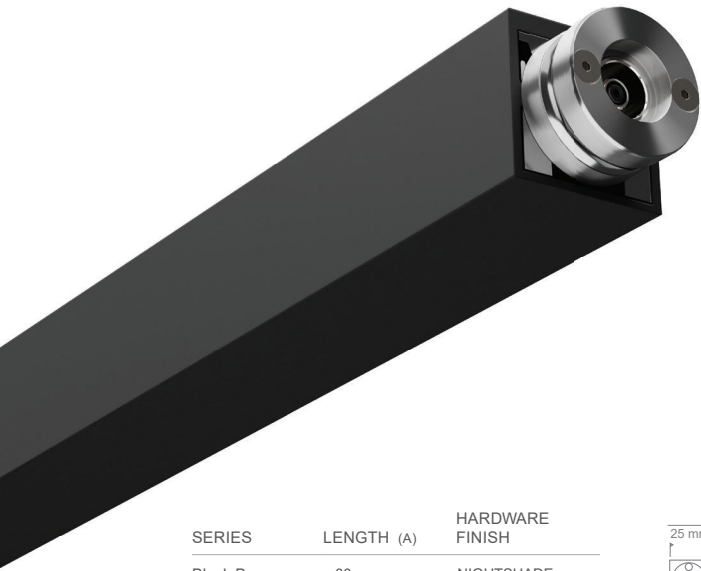

SERIES	LENGTH (A)	HARDWARE FINISH
Black Bar	30cm 60cm 120cm 180cm	NIGHTSHADE BLACK



CONNECTORS



I CONNECTOR

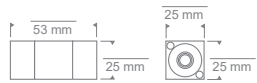

T CONNECTOR

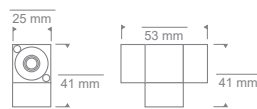

L CONNECTOR

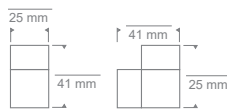

CORNER CONNECTOR

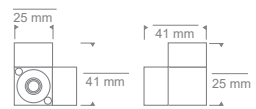

4-WAY CONNECTOR

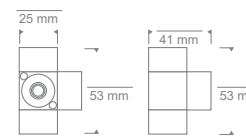

5-WAY CONNECTOR

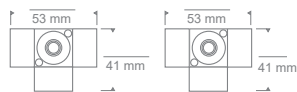

X CONNECTOR

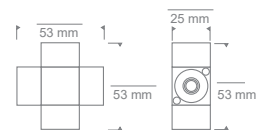

END CAP

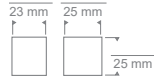

MOUNTING



WALL CONNECTOR

Ships with wall anchors.
May be used in ceiling.



AIRCRAFT CABLE SUPPORT

Clip on connectors or bars
to provide support anywhere
along the run.

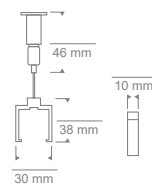

AIRCRAFT CONNECTOR

Mounts to any connector to
provide additional support.

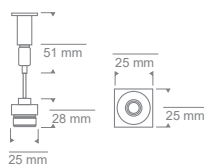

POWER



**SURFACE DRIVER
AND CANOPY**

Includes 80 Watt electronic
driver (230V input |
24V DC output).

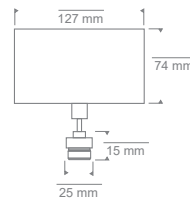

REMOTE DRIVER AND CANOPY

Includes 80 Watt electronic driver
(230V input | 24V DC output)
or 80 watt 0-10V driver
(230V input | 24V DC output)

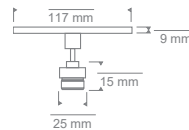

PRE-CONFIGURED SYSTEMS

Pre-configured 12" Square, 24" Square and 48" Rectangle systems can be used as stand-alone fixtures or can be interlinked as floating cubes to add depth to room decor and architecture.

30cm Cubic

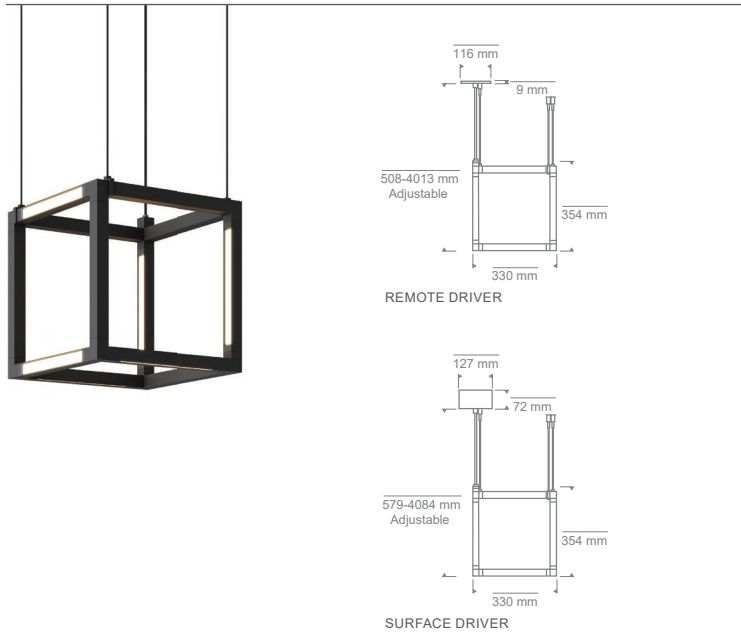

60cm Cubic

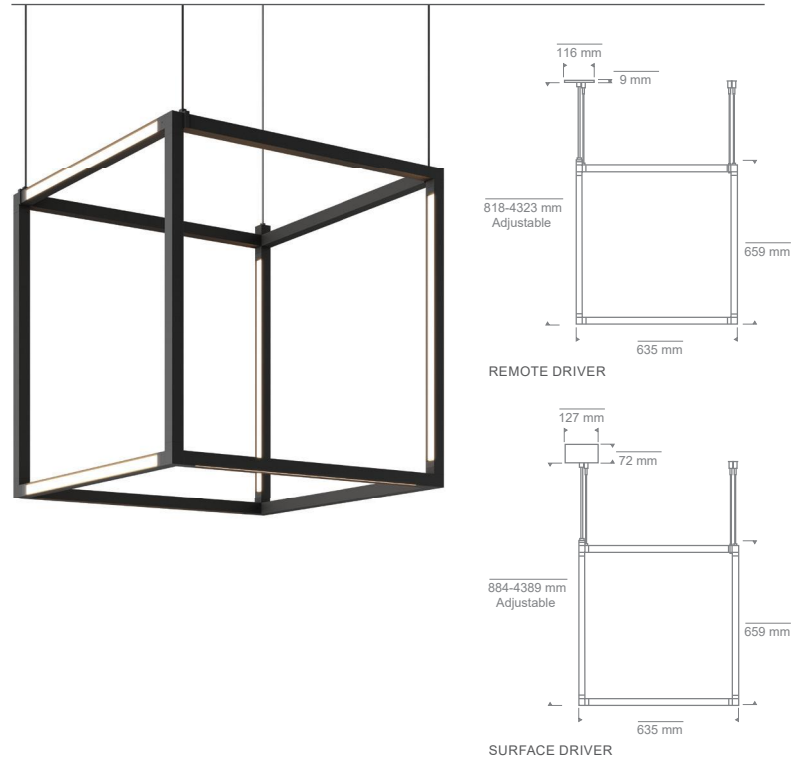

120cm RECTANGLE

